

GAMA SONIC[®]
SOLAR LIGHTING

2024

TABLE OF CONTENTS

Gama Sonic® - Who we are	3	Sentry Modern Pathway Light	59
Why Breakthrough Technology Matters	4	Solar Garden Light Shepherd Hook	60
Commercial Series By Gama Sonic®	6	Dual Color Premier Garden Dual Light	61
Centennial Commercial Solar LED Post Light	8	Progressive Solar Spotlight	62
Modern Commercial Solar LED Post Light	10	Luxor Stainless Steel Bollard Solar Light Luxor Solar Pathway Light	63
Denali Commercial Solar LED Post Light	12	Luxor Solar Post Cap Light	64
Imperial III Commercial Solar Post Light	14	Gothic Solar Post Cap Light	65
Contemporary Square Solar Post Light	16	Solar Uplight Planter Base	66
Imperial Bulb ATS Commercial Solar Post Light	17	Luna II Solar Post Cap/Pier Mount Light	67
Everest II Commercial Solar Lamp	18	Architectural Solar Wall Accent Light	68
Plaza Solar Light	19	Mosaic Tea Candle Solar Light	70
Solar Flood Light	20	Emergency and Camping Solar Flashlight	71
Solar Security & Area Light	21	Light My Shed® IV	72
Solar Pillar Commercial Bollard	22	Solar Yard Light	73
Vantage Bollard Solar Pathway Light	23	Bulbs	74
Residential Series by Gama Sonic®	24	Batteries	74
Victorian Morph Solar Light	26	Accessories	74
Victorian Bulb Solar Light	27	Posts	75
Aria Solar Light	28		
Royal Bulb Solar Light Brushed Bronze	30		
Royal Bulb Solar Light Black	32		
Royal Bulb Solar Light Weathered Bronze	33		
Baytown Bulb Solar Lamp	34		
Baytown II Bulb Solar Lamp	35		
Polaris Solar Light	36		
Pagoda Bulb Solar Lamp	37		
Silo Solar Light	38		
Aurora Bulb Solar Light	39		
Prairie Bulb Solar Light Grand Prairie Bulb Solar Light	40		
Topaz Solar Lamp	41		
Inversee Bulb Solar Light	41		
Orion Solar Light	42		
Windsor Bulb Solar Light	43		
Amphora Bulb Solar Light	44		
Casita Solar Post Light	45		
Imperial Bulb Solar Post Light	46		
Imperial Bulb II Solar Post Light	47		
Everest Solar Lamp	48		
Aspen Solar Light	49		
Spiral Solar Light	50		
Solar Coach Lantern	51		
Farmhouse Solar Light	52		
Infinity Solar Up and Down Wall Light	53		
Cottage Solar Barn Light	54		
Solar Address Wall Plaque Light	55		
Solar Address Light	55		
Modern Solar Post Light	56		
Stainless Steel Bollard Solar Light	57		
Contemporary Square Solar Path Light	58		

Who We Are

Gama Sonic® is the world leader in upscale, high quality solar lighting for homes, businesses and outdoor spaces. We develop, manufacture and market residential and commercial/industrial grade, energy-efficient outdoor solar powered lighting products. Since 2001, our multiple patented technologies have introduced innovative and cost-effective outdoor solar lighting solutions that provide unsurpassed levels of illumination and reliability. Gama Sonic® distributes products around the globe.

OUR MISSION

Our singular mission is to provide a solar solution for replacing traditional gas and electrical fixtures with an equivalent look, quality, duration and brightness. Gama Sonic® Solar lights can be easily installed anywhere outdoors without any electrical wiring, trenching or digging, and most importantly, without compromising performances of traditional lighting.



Our Story

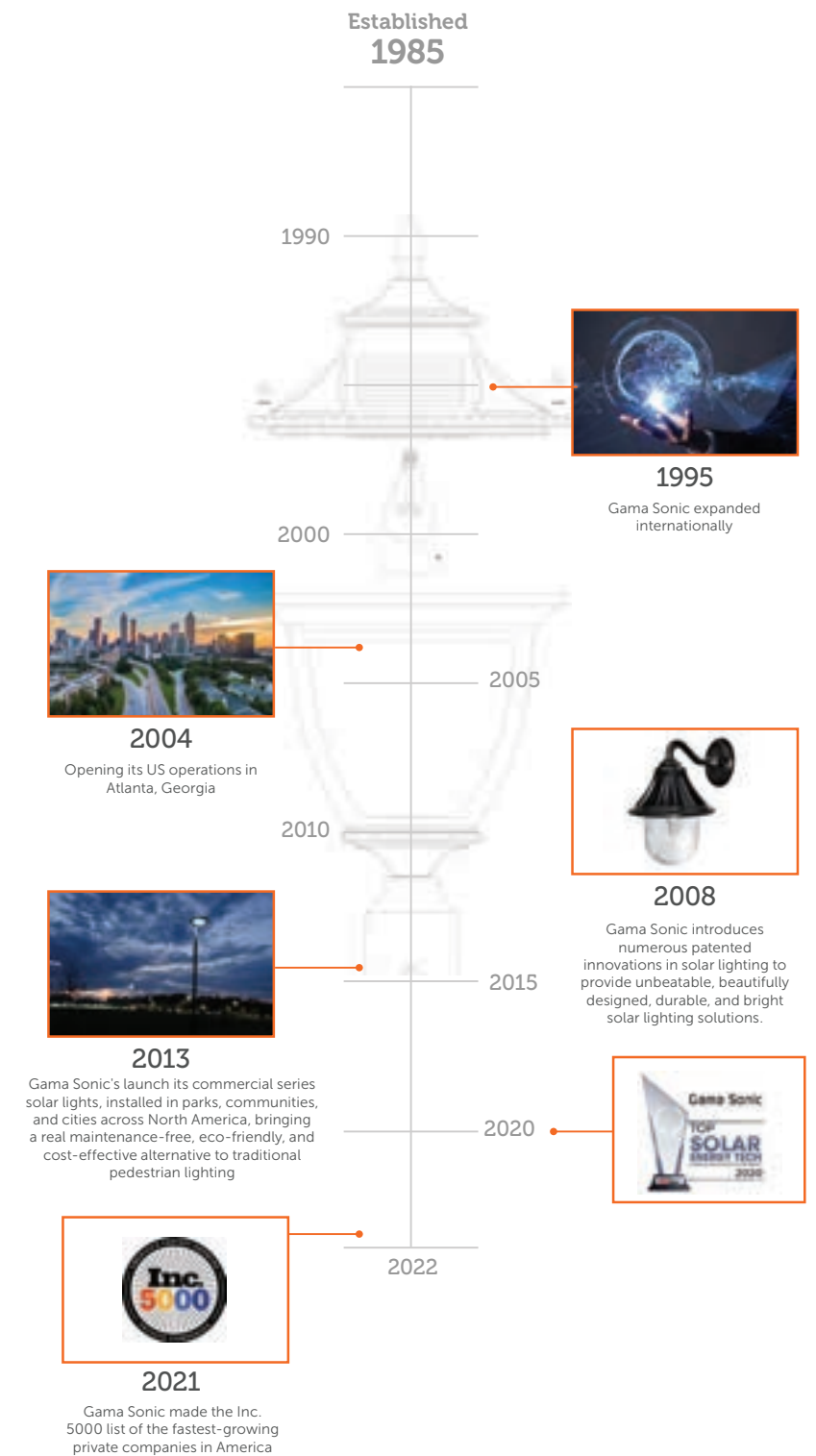











Why Breakthrough Technology Matters

Over Twenty (20) Design and Utility Patents

No matter what outdoor lighting challenges you face, choosing a technology-rich solution makes all the difference. Solar-powered products have been around for years, but it took the research and development expertise of Gama Sonic® engineers to create rechargeable solar lighting designs that outshine and outlast every major competitor. We stay ahead of the design curve by creating and testing products that fit a wide variety of residential and commercial applications.

What this means to you: Enjoying a safer, more reliable, and more cost-effective investment for your lighting budget.

 LED Technology	 Easy Installation	 No Wiring
 Weather Resistant	 Maintenance Free	 Cost Efficient
 Eco Friendly	 2 Year Warranty (Residential Products)	 5 Year Warranty (Commercial Products)



GS Cone Technology is a patented technology which allows our solar lamps to disburse more light efficiently and spreading the directional LED rays down and around the light fixture.

Patent #7172307



Morph Solar Panel Technology is our ground-breaking process of capturing more power from the sun. Monocrystalline solar cells are molded to the surface of the lamp, "morphing" the lamp into a solar panel.



Translucent Solar Panel (TSP) is an industry changing technology that transforms the largest surface areas of the light fixture into solar panels - the glass panes. This innovative technology embeds the monocrystalline solar cells into the glass, maximizing the power from the sun.



Automatic Tracking System (ATS) technology is revolutionizing the way to maximize the sun's rays in charging solar lights. This technology, previously used in large solar farms, is now available to the consumer to track the sun throughout the day and provides a longer lasting and brighter light.

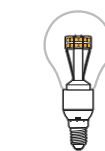

GS Solar LED Light Bulb is a patented technology that replicates the conventional look and feel of the traditional bulb in outdoor solar-powered lamps.

Patent #9458970

Commercial Series by **GAMA SONIC®**

Since 2013, Gama Sonic's Commercial Series line has been installed in parks, communities and cities across North America, bringing a real maintenance-free, eco-friendly, and cost-effective alternative to traditional pedestrian lighting.

Our Partners:





Centennial Commercial Solar LED Post Light

- Commercial grade construction
- Coastal approved
- IP65 - weather resistant rating
- 64 SMD LEDs
- Corrosion resistant powder-coated cast aluminum
- 22W tempered glass SunPower™ solar panel
- Exterior low/off/high switch
- Automatic dusk to dawn operation
- Patent #7172307

1000
LUMENS



4-8
NIGHTS
DURATION

3X 
LIFEPO4 batteries
GS12_8V60
GAMA SONIC
BATTERY

IMPROVED BRIGHTNESS

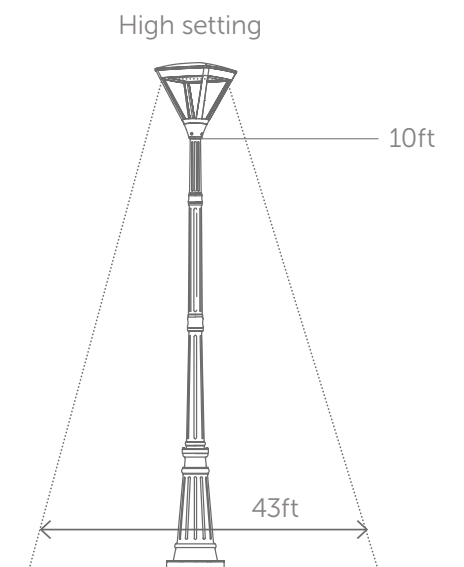

100012
3" Fitter



*Beam diameter is based on quantity of illumination [IES Recommended Light Levels] RP-8-18 for Walkways/Bikeways of a minimum 0.2 Foot Candle.

The Centennial Solar Light is a commercial grade, high-performance solar lamp providing a stunning 1000 lumens of bright white (6000K) light for up to 8 nights. This solar lamp's weather resistant, coastal approved construction is perfect for commercial and residential areas such as pedestrian walkways, parking lots, and community parks. The Centennial Solar Light is the practical solution for any outdoor lighting application.

Part #	Dimensions	UPC	Wgt	LED Color	Lamp Color
100012	18.5L x 18.5W x 20H	859641007240	30	Bright White (6000K)	Black
100012-5	18.5L x 18.5W x 20H	859641007240	30	Warm White (2700K)	Black



Modern Commercial Solar LED Post Light w/ Motion Sensor and Timer

- Commercial grade construction
- Coastal approved
- IP65 - weather resistant rating
- 24 SMD LEDs
- Corrosion resistant powder coated cast aluminum
- Powered by efficient monocrystalline solar panel
- Exterior low/off/high switch
- Automatic dusk to dawn operation
- 140° Detection zone
- 2 modes of operation: PIR / Constant On
- 20W tempered glass solar panel
- Timer feature allows 4-8 hours of duration or dusk to dawn operation



4,5,6,7,8 hours duration
or 0 for dusk to dawn
operation

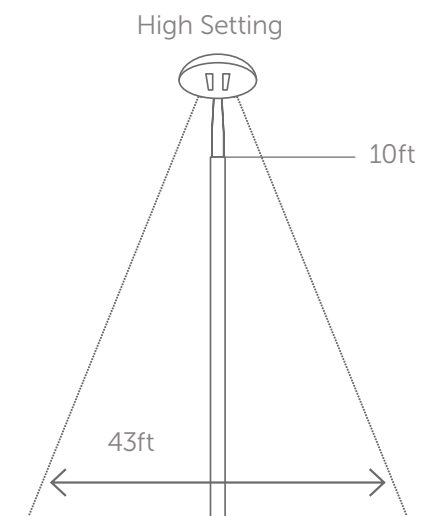

*Beam diameter is based on quantity of illumination [IES Recommended Light Levels] RP-8-18 for Walkways/Bikeways of a minimum 0.2 Foot Candle.

The unique, contemporary style of the Modern Commercial Grade Solar Post Light makes it perfect for any outdoor space, especially parks, commercial grounds, and residential communities. It fits standard 3" posts and is an excellent choice for replacing and retrofitting outdated gas or traditional electric lights. The light turns on automatically from dusk until dawn and, for added versatility, allows you to choose between a high or low output at the flip of a switch.

Part #	Dimensions	UPC	Wgt	LED Color	Lamp Color
102IST60012	19.5L x 19.5W x 28H	859641008261	24.6	Bright White (6000K)	Black



Denali Commercial Solar LED Post Light w/ Timer

- Commercial grade construction
- 33 SMD LEDs
- IP65 - weather resistant rating
- Powered by efficient monocrystalline solar panels
- Morph Technology
- Automatic dusk to dawn operation
- UV inhibited polycarbonate weather resistant lamp head
- Powder coated cast-aluminum weather resistant structure
- 26W solar panel
- Timer feature allows 4-8 hours of duration or dusk to dawn operation



600
LUMENS

3-6
NIGHTS
DURATION

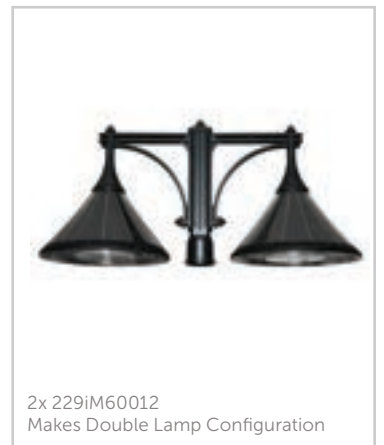
2X 
GS32V12A
GAMA SONIC
BATTERY

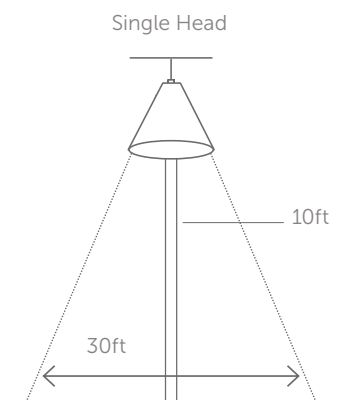
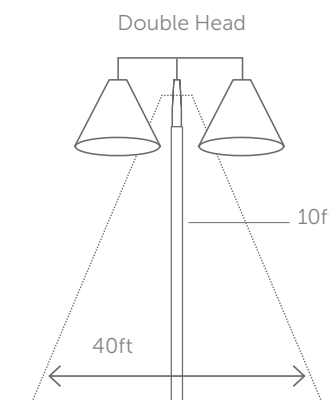

4,5,6,7,8 hours duration
or 0 for dusk to dawn
operation



*Beam diameter is based on quantity of illumination [IES Recommended Light Levels] RP-8-18 for Walkways/ Bikeways of a minimum 0.2 Foot Candle.

Gama Sonic's Denali is a commercial grade pedestrian lighting featuring Gama Sonic's exclusive Morph Technology where the solar panels are morphed into the light fixture for more powerful solar charge and longer light output. Mount the Denali as a single head or double head, this beautifully designed solar post light can be used to illuminate parks, communities, sidewalks, and campgrounds.

Part #	Dimensions	UPC	Wgt	LED Color	Lamp Color
229iM60012	23.125 L x 16.5W x 19.875H	859641008292	13	Bright White (6000K)	Black



Imperial III Commercial Solar Post Light

- Commercial grade construction
- 21 SMD LEDs
- Dual color - bright white/warm white
- Automatic dusk to dawn operation
- Powered by efficient monocrystalline solar panels
- Powder coated cast-aluminum weather resistant structure
- Beveled glass panes
- Patent #7172307
- 8W tempered glass solar panel

300
LUMENS

3-6
NIGHTS
DURATION

4X 
GS32V30
GAMA SONIC
BATTERY

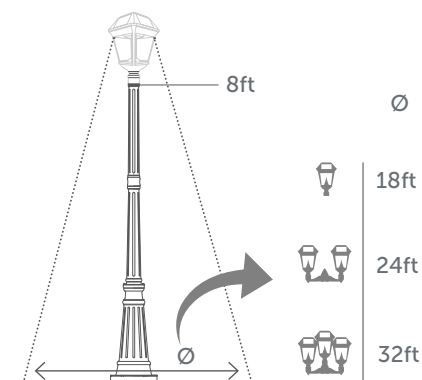
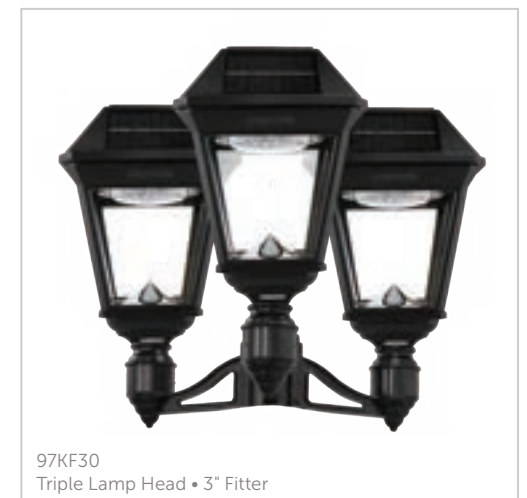

*Beam diameter is based on quantity of illumination [IES Recommended Light Levels] RP-8-18 for Walkways/Bikeways of a minimum 0.2 Foot Candle.

The Imperial III Solar Light is a commercial grade solar lamp featuring both a warm-white (2700K) and bright white (6000K) light temperature, provided at a brilliant 300/600/900 lumens and for up to 6 nights (300 lumen per lamp). Continuing the Imperial series reputation for durability, functionality and style, its weather resistant construction is perfect for commercial and residential areas such as pedestrian walkways, parking lots, and community parks.

Part #	Dimensions	UPC	Wgt	LED Color	Lamp Color
97K012	10.5L x 10.5W x 19.5H	859641007462	9.4	Bright White (6000K) + Warm White (2700K)	Black
97KF20	30L x 10.5W x 21.5H	859641007639	21.2		
97KF30	26.5L x 24.5W x 21.5H	859641007646	31.2		

Contemporary Square Solar Post Light w/ Timer



- Powered by efficient monocrystalline solar panels
- Automatic dusk to dawn operation
- Corrosion resistant powder coated cast aluminum
- 3 color temperature options: Warm White (3000K) / Natural White (4000K) / Bright White (5000K)
- 14W tempered glass solar panel
- 2 mounting options: center mount and side mount
- Timer feature allows 4-8 hours of duration or dusk to dawn operation

500 LUMENS
2-4 NIGHTS DURATION
GS32V15A GAMA SONIC BATTERY



TIMER

4, 5, 6, 7, 8 hours duration or 0 for dusk to dawn operation

Part #	Dimensions	UPC	Wgt	LED Color	Lamp Color
217i20001	17.5L x 12.25W x 98.75H	859641008780	19	3000K/4000K/5000K	Black
217i20012	12.25L x 12.25W x 5H	859641008797	7.4		

Imperial Bulb ATS Commercial Solar Post Light



- Automatic Tracking System
- Commercial grade construction
- Automatic dusk to dawn operation
- Powered by efficient monocrystalline solar panel
- Powder coated cast-aluminum weather resistant structure
- Beveled glass panes
- Patents #7172307, #9458970
- 10W tempered glass solar panel

550 LUMENS
3-6 NIGHTS DURATION
2X GS37V10_4A GAMA SONIC BATTERY

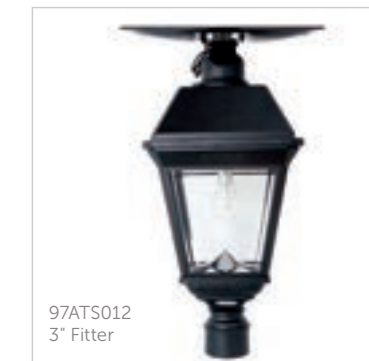

ATS AUTOMATIC TRACKING SYSTEM

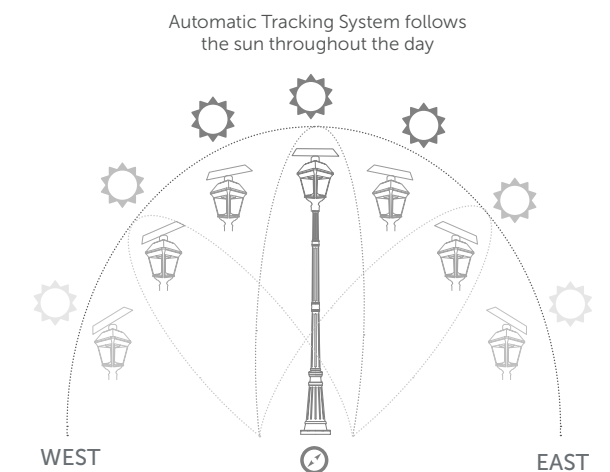
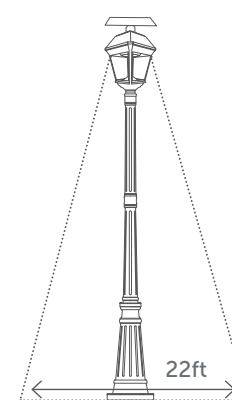
 Includes Part #A60WW30W (Bright white sold separately)

*Beam diameter is based on quantity of illumination [IES Recommended Light Levels] RP-8-18 for Walkways/Bikeways of a minimum 0.2 Foot Candle.

Part #	Dimensions	UPC	Wgt	LED Color	Lamp Color
97ATS012	13.5L x 9.5W x 24H	859641007349	13.7	Warm White (2700K)	Black

Everest II Commercial Solar Lamp



- Commercial grade construction
- Automatic dusk to dawn operation
- Powered by efficient monocrystalline solar panel
- Cast-aluminum all weather-resistant structure with UV protection
- Exterior low/off/high switch
- Acrylic lens
- Patent #9458970
- 10W tempered glass solar panel

500
LUMENS

5-10
NIGHTS
DURATION

GS37V27A
GAMA SONIC
BATTERY

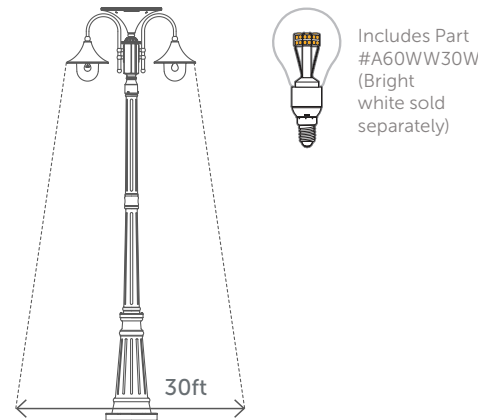
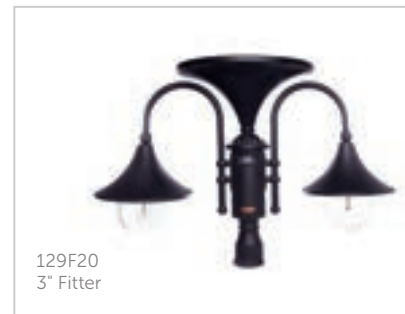

*Beam diameter is based on quantity of illumination [IES Recommended Light Levels] RP-8-18 for Walkways/Bikeways of a minimum 0.2 Foot Candle.

Part #	Dimensions	UPC	Wgt	LED Color	Lamp Color
129F20	15.75L x 34W x 23H	859641007233	23	Warm White (2700K)	Black

Plaza Solar Light



- Morph technology
- Powered by efficient monocrystalline solar panels
- Automatic dusk to dawn operation
- UV inhibited polycarbonate lamp head
- Powder coated cast-aluminum structure
- Rigid ABS resin weather resistant structure
- Cast-aluminum mounting arm/bracket
- Exterior low/off/high switch
- Patent #9458970
- 8W solar panel

180
LUMENS

2
NIGHTS
DURATION

2X 
GS32V30
GAMA SONIC
BATTERY



119B50044
Plaza Solar RLM Light
w/ Adjustable Gooseneck Arm



119BM50022
Plaza Solar Post/Wall Light

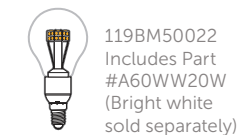

119B50044
Includes Part #
A60WW20W-DIR



Part #	Dimensions	UPC	Wgt	LED Color	Lamp Color
119B50044	11L x 42W x 21H	859641007356	10.12	Warm White (2700K)	Black
119BM50022	10.63L x 10.63W x 18.25H	859641007950	3.6		

Solar Flood Light



- IP65 - weather resistant rating
- Automatic dusk to dawn operation
- 20 bright SMD LEDs
- Cast-aluminum weather resistant structure
- 2 mounting options
- Exterior low/off/high switch
- 4W tempered glass solar panel
- Detachable panel with 6ft cord

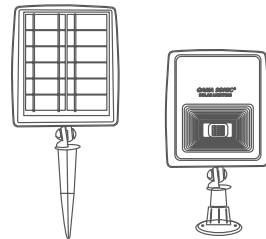
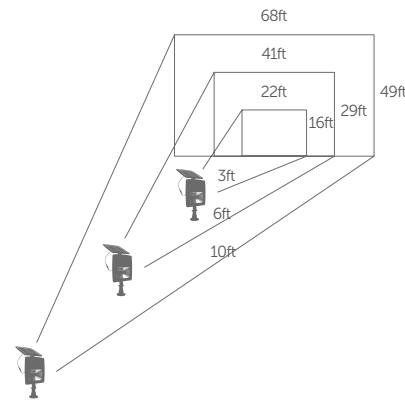

250
LUMENS

Up to 20
HOURS
DURATION

2X
GS37V40
GAMA SONIC
BATTERY

Part #	Quantity	Dimensions	UPC	Wgt	LED Color	Lamp Color
203001	1 Pack	2.5L x 8W x 18H	859641007165	6	Bright White (6000K)	Black
203IP260090	2 Pack		859641008094			
203001-5	1 Pack		859641007172			
203IP250090	2 Pack		859641008179			

Solar Security & Area Light with Motion Sensor and Timer



- 810 Lumens (as Security Light)
- 100 Cycles (as Security Light)
- 270 Lumens (as Area Light)
- Up to 1 nights duration (as Area Light)
- GS37V60 Battery
- 4W tempered glass solar panel



- 1620 Lumens (as Security Light)
- 150 Cycles (as Security Light)
- 500 Lumens (as Area Light)
- Up to 2 nights duration (as Area Light)
- GS37V16A Battery
- 10W tempered glass solar panel



- 2800 Lumens (as Security Light)
- 150 Cycles (as Security Light)
- 980 Lumens (as Area Light)
- Up to 2 nights duration (as Area Light)
- GS32V24A Battery
- 16W tempered glass solar panel

- IP65 - weather resistant rating
- 2 mounting options
- ABS plastic housing optimal for outdoor usage
- PIR/off/on switch
- 2 modes of operation: PIR or constant on
- Timer feature allows 4-8 hours of duration or dusk to dawn operation

Integrated PIR
motion sensor



PIR Mode: Light turns on when motion is detected
On Mode: Constant on



4,5,6,7,8 hours duration or 0 for dusk to dawn operation

Part #	Dimensions	UPC	Wgt	LED Color	Lamp Color
101iS60822	12L x 6W x 2H	859641008223	2	Bright White (6000K)	Dark Grey
201iS60822	20L x 8.5W x 2H	859641007837	5.5		
301iS60822	22.50L x 10.25W x 4H	859641008346	11.10		

Solar Pillar Commercial Bollard



- Bifacial solar panel technology
- 2 modes of operation: PIR 150 cycles/constant on mode with dusk to dawn operation
- Cast-aluminum weather resistant structure
- Bi-directional or mono-directional Light output
- 19W tempered glass solar panel

Integrated PIR motion sensor

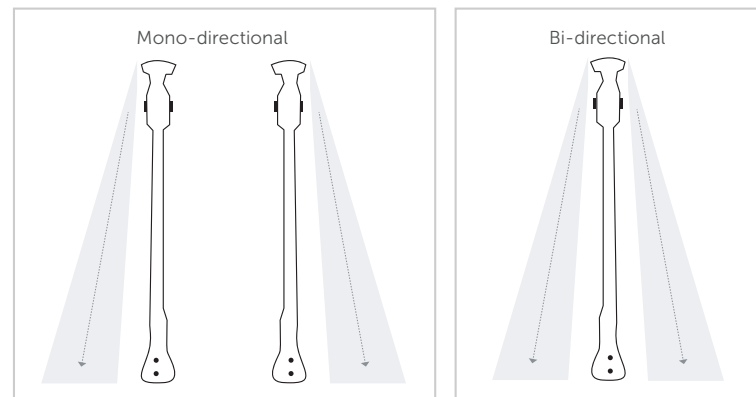
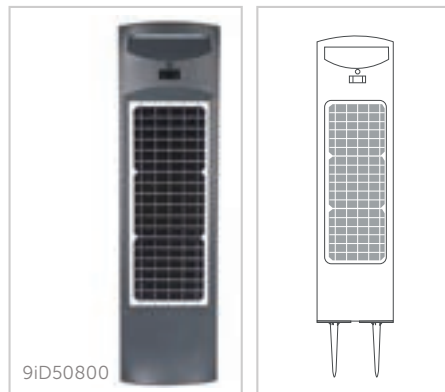

500 LUMENS

up to 2 NIGHT DURATION

GS64V60 GAMA SONIC BATTERY

Part #	Dimensions	UPC	Wgt	LED Color	Lamp Color
9iD50800	8.75L x 3.5W x 31.25H	859641007851	11	Warm White (3000K)	Black

Vantage Bollard Solar Pathway Light



- Powered by efficient monocrystalline solar panels
- Automatic dusk to dawn operations
- Cast-aluminum weather resistant structure
- Patents #9458970, #7172307
- 4.5W tempered glass solar panel
- 2 installation mounting option included: flat mount and stake mount

200 LUMENS

up to 3 NIGHTS DURATION

3X GS32V30 GAMA SONIC BATTERY



Includes Part #A60BW20W (Bright white sold separately)

Part #	Quantity	Dimensions	UPC	Wgt	LED Color	Lamp Color
314B50000	1 Pack	10.25L x 10.25W x 31.25H	859641008407	4.4	Warm White (2700K)	Black
314BP250000	2 Pack		854433001086			

Residential Series by **GAMA SONIC®**

Gama Sonic's Residential series solar lights can upgrade your home's curb appeal while using renewable energy from the sun to illuminate your home's outdoor areas. We help homeowners achieve a notable exterior home upgrade with very little effort or cost, inviting them to give their home an impressive, yet quick and easy facelift with upscale solar lighting.

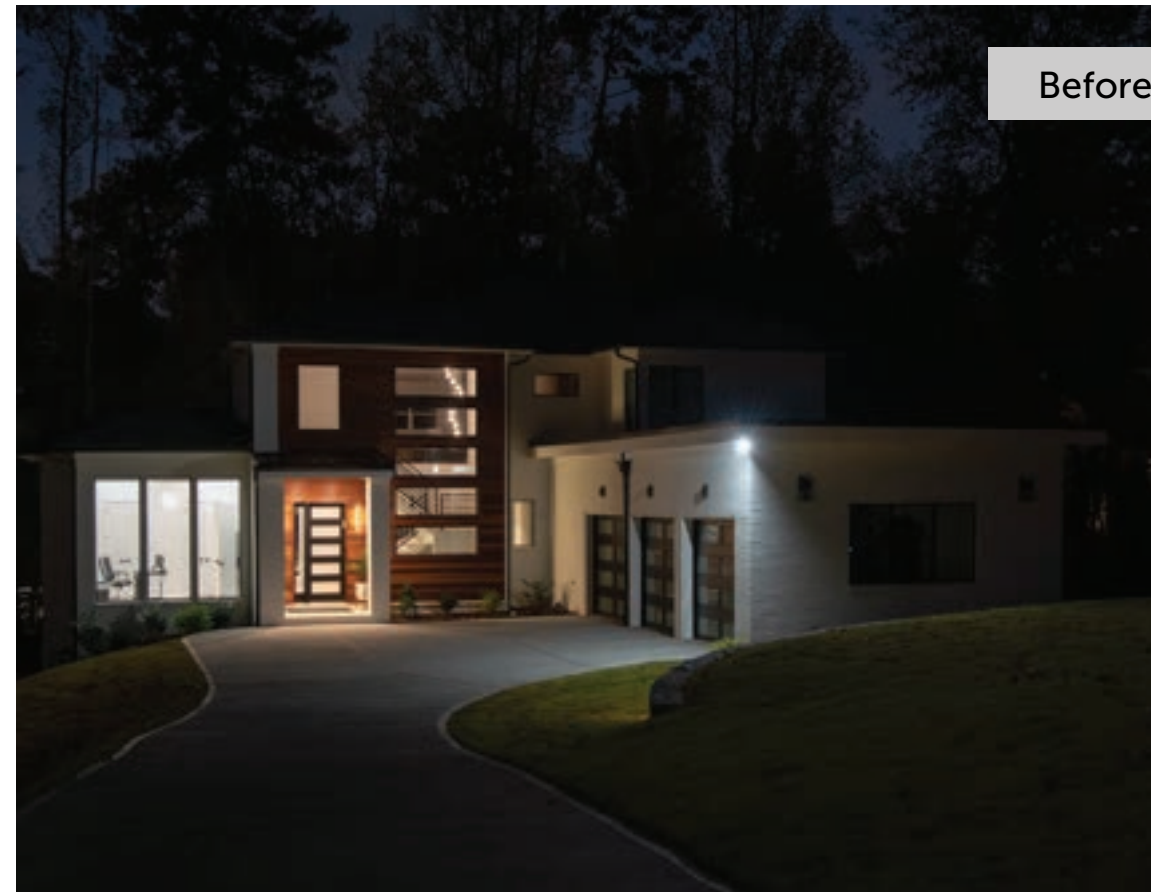

Before & After



Before & After



Victorian Morph Solar Light



- Powered by efficient monocrystalline solar panels
- Morph Technology
- Automatic dusk to dawn operation
- Cast-aluminum weather resistant structure
- Beveled glass panes
- Patents #7172307, #9458970
- 5.4W tempered glass solar panel

150
LUMENS

up to 2
NIGHTS
DURATION

2X
GS32V30
GAMA SONIC
BATTERY

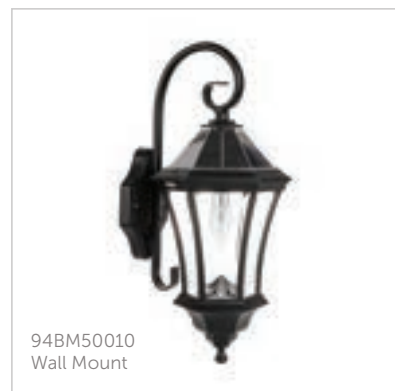

Includes Part
#C37WW10W
(Bright white sold
separately)



Part #	Dimensions	UPC	Wgt	LED Color	Lamp Color
94BM50010	11.375L x 9.25W x 21.25H	859641008247	10	Warm White (2700K)	Black
94BM500D2	10.25L x 25.25W x 99.75H	859641008230			

Victorian Bulb Solar Light



Integrated PIR
motion sensor

- Powered by efficient monocrystalline solar panels
- Automatic dusk to dawn operation
- Cast-aluminum weather resistant structure
- Exterior low/off/high switch
- Beveled glass panes
- Patents #7172307, #9458970
- 2.4W tempered glass solar panel

150
LUMENS

up to 2
NIGHTS
DURATION

GS32V30
GAMA SONIC
BATTERY

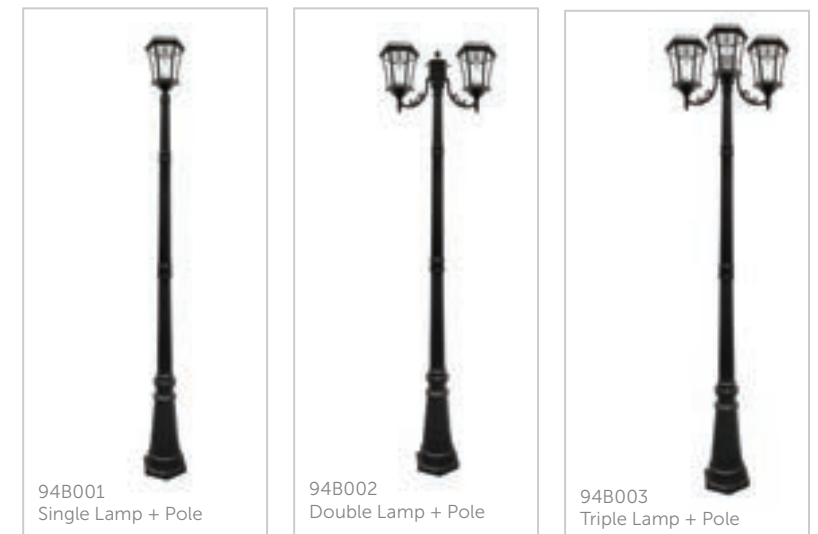

Includes Part
#C37WW10W
(Bright white sold
separately)

Part #	Dimensions	UPC	Wgt	LED Color	Lamp Color
94B001	8L x 9.5W x 90H	853153005725	12.5	Warm White (2700K)	Black
94B002	8L x 25W x 87H	853153005732	19.5		
94B003	25L x 25W x 87H	853153005749	26.5		
94B033	8L x 9.5W x 15H	854433001505	7		White
94B233	8L x 9.5W x 15H	185455000208			Black
94BS50033	8L x 9.5W x 15H	859641008001	4.4		



Aria Solar Light

- Powered by efficient monocrystalline solar panels
- Automatic dusk to dawn operations
- Cast-aluminum weather resistant structure
- Patents #9458970, #D629950
- 5.6W trapezoid tempered glass solar panel

150
LUMENS

up to 12
HOURS
DURATION

GS32V30
GAMA SONIC
BATTERY

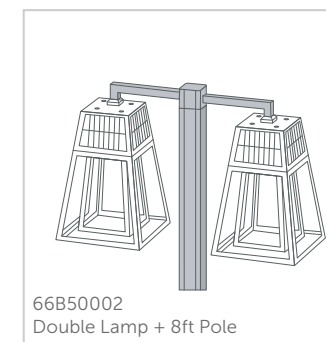
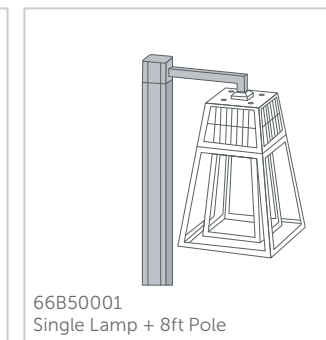

 Includes Part #A60WW20W (Bright white sold separately)

Gama Sonic's Aria Solar Wall Light is a beautiful, modern solar wall light designed to brighten any outdoor space. The Aria's 4 solar panels will maximize solar charge for longer light duration. There is no wiring required with this simple installation so your home's walkways, entryway, and backyard will quickly be illuminated with high-quality, solar lighting LED output with automatic dusk-to-dawn operation.

Part #	Dimensions	UPC	Wgt	LED Color	Lamp Color
66B50010	11.25L x 9.38W x 17.38H	859641008384	6	Warm White (6000K)	Black
66B50001	16.75L x 9.375W x 99H	859641008810	17.2		
66B50002	9.375L x 26W x 99H	859641008810	22.6		



Royal Bulb Solar Light Brushed Bronze

IMPROVED: 60% More Charging Power

- Automatic dusk to dawn operation
- Cast-aluminum weather resistant structure
- Rain glass panes
- Patents #7172307, #9458970
- 6W tempered glass solar pane

120
LUMENS

up to 12
HOURS
DURATION

2X 
GS32V15
GAMA SONIC
BATTERY



 Includes Part #A50WW10W (Bright white sold separately)

The Royal Bulb Solar Lamp Series is constructed of weather resistant, powder-coated brushed bronze cast aluminum and rain glass panes. The lights feature an attractive design inspired by New Orleans architecture. It incorporates our cutting-edge GS Solar LED Light bulb technology and provides 360-degree illumination. Now available with 2.5X larger solar panels for more charging power.

Part #	Dimensions	UPC	Wgt	LED Color	Lamp Color
98B110	12.5L x 8.75W x 21H	859641007059	7	Warm White (2700K)	Brushed Bronze
98B111	8.75L x 8.75W x 23H	859641007042	9.5		
98B112	8.75L x 8.75W x 18H	859641007035	9.5		
98B101	8.75L x 8.75W x 87H	859641007011	15		

Royal Bulb Solar Light Black



IMPROVED: 60% More Charging Power

- Automatic dusk to dawn operation
- Cast-aluminum weather resistant structure
- Beveled glass panes
- Patents #7172307, #9458970
- 6W trapezoid tempered glass solar panel

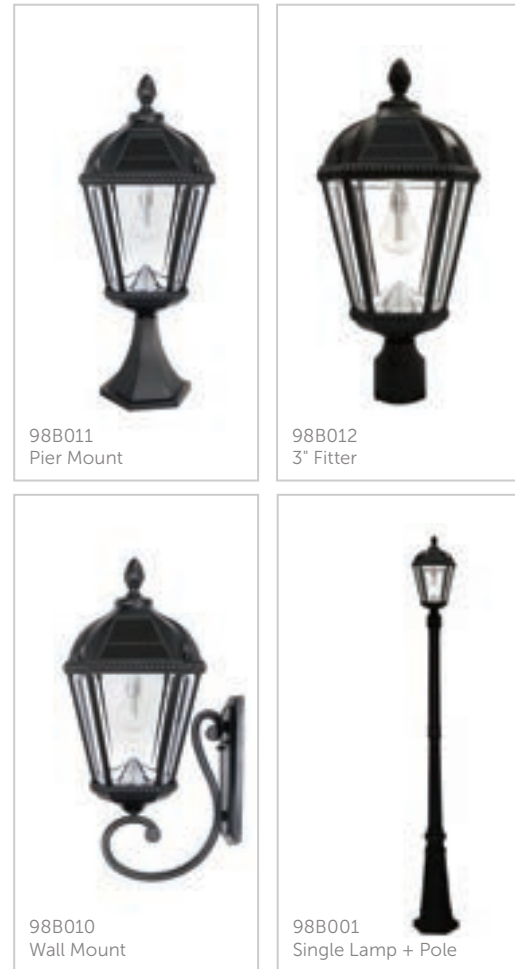

Part #	Dimensions	UPC	Wgt	LED Color	Lamp Color
98B011	8.75L x 8.75W x 23H	859641007400	7.5	Warm White (2700K)	Black
98B012	8.75L x 8.75W x 18H	853153005930	6.5		
98B010	12.5L x 8.75W x 21H	859641007417	9.5		
98B001	8.75L x 8.75W x 23H	859641007400	7.5		

Royal Bulb Solar Light Weathered Bronze

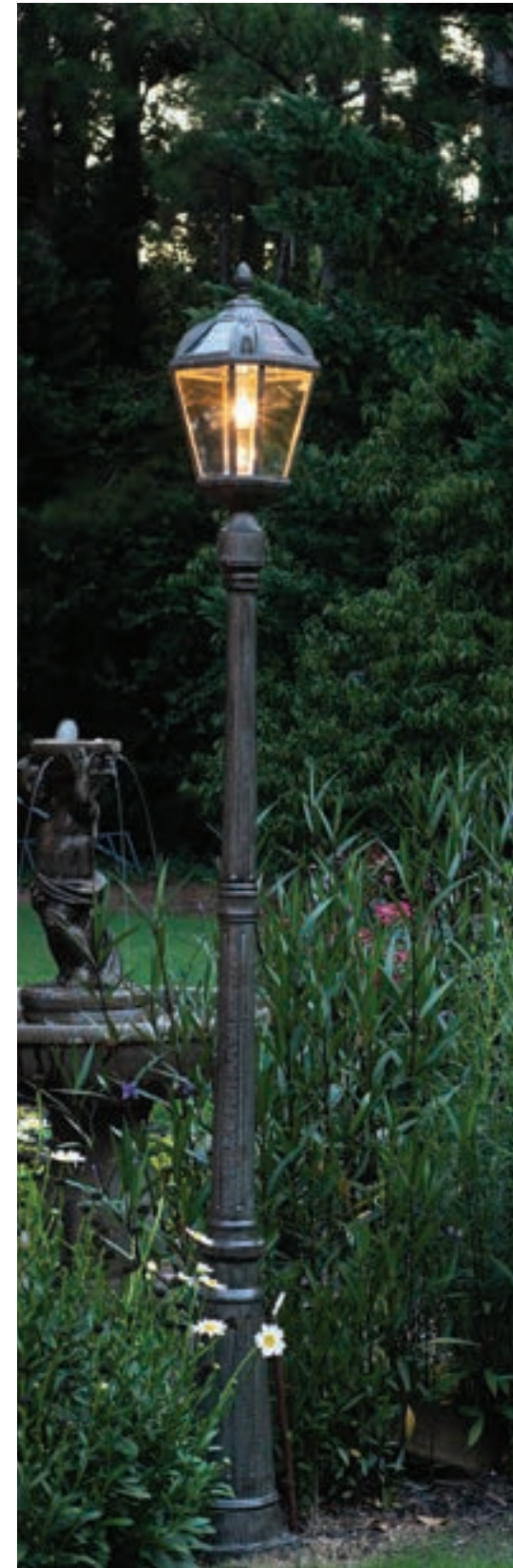

IMPROVED: 60% More Charging Power

- Automatic dusk to dawn operation
- Cast-aluminum weather resistant structure
- Beveled glass panes
- Patents #7172307, #9458970
- 6W trapezoid tempered glass solar panel

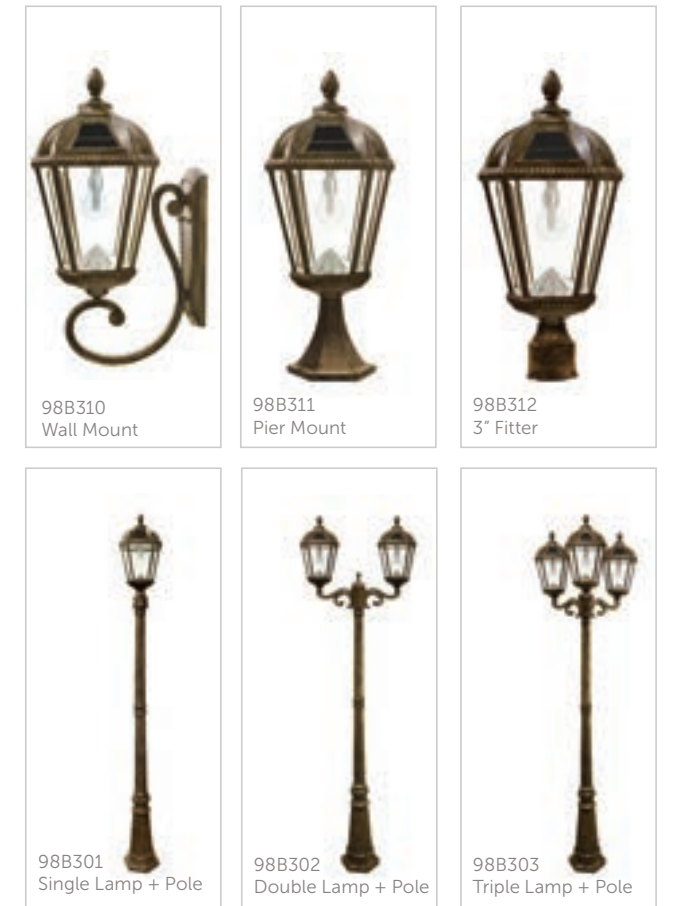

Part #	Dimensions	UPC	Wgt	LED Color	Lamp Color
98B310	12.5L x 8.75W x 21H	853153005923	9.5	Warm White (2700K)	Weathered Bronze
98B311	8.75L x 8.75W x 23H	853153005916	7.5		
98B312	8.75L x 8.75W x 18H	853153005909	6.5		
98B301	8.75L x 8.75W x 87H	853153005879	15		
98B302	8.75L x 27W x 89H	853153005886	24		
98B303	27L x 27W x 89H	853153005893	30		

Baytown Bulb Solar Lamp



- Automatic dusk to dawn operation
- Cast-aluminum weather resistant structure
- Beveled glass panes
- Patents #7172307, #9458970
- 2W tempered glass solar panel

80
LUMENS

up to 12
HOURS
DURATION

GS32V15
GAMA SONIC
BATTERY



 Includes Part #A50WW10W (Bright white sold separately)



Part #	Dimensions	UPC	Wgt	LED Color	Lamp Color
106B50233	8.25L x 8.25W x 17H	859641008117	7	Warm White (2700K)	White
106B033	8.25L x 8.25W x 17H	853153005015	7		Black
106BPLSG0	15L x 15W x 77H	853153005992	19		White
106B133	8.25L x 8.25W x 17H	185455000932	7		Brushed Bronze

Baytown II Bulb Solar Lamp



- Automatic dusk to dawn operation
- Weather resistant structure
- Rigid ABS resin exterior
- Patents #7172307, #9458970
- 3.2W tempered glass solar panel

130
LUMENS

up to 12
HOURS
DURATION

GS32V15
GAMA SONIC
BATTERY



 Includes Part #A50WW10W (Bright white sold separately)



250 Lumens
3W panel
A-60 Bulb
 **GS32V30**
GAMA SONIC
BATTERY

100 Lumens
2W panel
C-37 Bulb

Part #	Dimensions	UPC	Wgt	LED Color	Lamp Color
105BSG01	9.5L x 12W x 77H	185455000109	11	Warm White (2700K)	Black
105BCX01	9.5L x 9.5W x 18H	854433001604	5.6		
105BP250040	5L x 9.5W x 15.5H	859641007660	8.5		
105B033	9.5L x 9.5W x 19H	853153005022	5		White
105BSG21	9.5L x 12W x 77H	859641007813	11		
105BCX21	9.5L x 9.5W x 18H	859641007790	2.2		
105BP250240	5L x 9.5W x 15.5H	859641007783	1.6		
105B233	9.5L x 9.5W x 19H	859641007806	6		

Polaris Solar Light



- Coastal approved
- IP65 - weather resistant rating
- ABS rigid resin with UV protection
- Automatic dusk to dawn operation
- Patents #7172307, #9458970
- 4.2W tempered glass solar panel

130
LUMENS

up to 12
HOURS
DURATION

2X 
GS32V15
GAMA SONIC
BATTERY

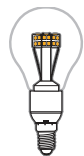

Includes Part
#A50WW10W
(Bright white sold
separately)

Part #	Dimensions	UPC	Wgt	LED Color	Lamp Color
178233	8.75L x 10W x 19.25H	185455000710	5.6	Warm White (2700K)	White
177B50002	9.13L x 27W x 91.88H	859641007974	15		Black
178033	8.75L x 10W x 19.25H	854433001499	5.6		Black
177010	10L x 9.5W x 12H	859641007219	4.2		Black

Pagoda Bulb Solar Lamp



- Automatic dusk to dawn operation
- Cast-aluminum weather resistant structure
- Clear glass panes
- Patents #7172307, #9458970
- 3.6W tempered glass solar panel

180
LUMENS

up to 2
NIGHTS
DURATION

GS32V30
GAMA SONIC
BATTERY

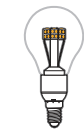

Includes Part
#A60WW20W
(Bright white sold
separately)

Part #	Dimensions	UPC	Wgt	LED Color	Lamp Color
104B033	14L x 11W x 22H	859641007325	12	Warm White (2700K)	Black
104B001	11L x 11W x 87H	859641007332	18		

Silo Solar Light



- Powered by efficient monocrystalline solar panels
- Automatic dusk to dawn operation
- Cast-aluminum weather resistant structure
- Clear rain glass
- Patent #9458970
- 1.6W tempered glass solar panel

100
LUMENS

up to 2
NIGHTS
DURATION

2X **GS32V15**
GAMA SONIC
BATTERY



Includes Part #A60WW20W (Bright white sold separately)

Part #	Dimensions	UPC	Wgt	LED Color	Lamp Color
20B50033	8L x 8W x 10.13H	859641008018	4.2	Warm White (2700K)	Black

Aurora Bulb Solar Light



- Powered by efficient monocrystalline solar panels
- Automatic dusk to dawn operation
- Cast-aluminum weather resistant structure
- Seeded glass
- Patents #7172307, #9458970
- 0.85W tempered glass solar panel

50
LUMENS

up to 12
HOURS
DURATION

GS32V15
GAMA SONIC
BATTERY



Includes Part #A50WW10W (Bright white sold separately)

Part #	Dimensions	UPC	Wgt	LED Color	Lamp Color
124B033	6.5L x 6.5W x 13H	859641007615	3	Warm White (2700K)	Black
124B50071	8L x 8W x 72.63H	859641007905	7.8		

Prairie Bulb Solar Light



50 LUMENS
up to 8 HOURS DURATION
GS36V08 GAMA SONIC BATTERY



- Automatic dusk to dawn operation
- Cast-aluminum weather resistant structure
- Clear glass panes
- Patents #7172307, #9458970
- 1.3W solar panel

Part #	Dimensions	UPC	Wgt	LED Color	Lamp Color
114B033	7L x 7W x 14H	185455000079	3.2	Warm White (2700K)	Black
114B50833		859641008377	3.2		Grey

Topaz Solar Lamp

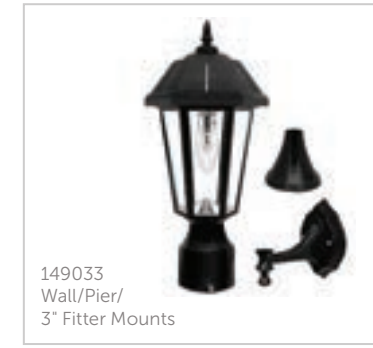

80 LUMENS
up to 2 nights HOURS DURATION
GS32V15 GAMA SONIC BATTERY



- Morph technology
- Powered by efficient monocrystalline solar panels
- Automatic dusk to dawn operation
- Cast-aluminum weather resistant structure
- Beveled glass panes
- Patents #7172307, #9458970
- 3.3W solar panel

Part #	Dimensions	UPC	Wgt	LED Color	Lamp Color
149033	6.75L x 6W x 15.5H	859641007196	4	Warm White (2700K)	Black

Grand Prairie Bulb Solar Light



150 LUMENS
up to 2 NIGHTS DURATION
GS32V30 GAMA SONIC BATTERY



- Automatic dusk to dawn operation
- Cast-aluminum weather resistant structure
- Clear glass panes
- Patents #7172307, #9458970
- 3W solar panel
- 3X brighter than the Prairie Bulb Solar Light

Part #	Dimensions	UPC	Wgt	LED Color	Lamp Color
115B50033	8.625L x 8.625W x 15.75H	859641007394	5.8	Warm White (2700K)	Black

Inversee Bulb Solar Light

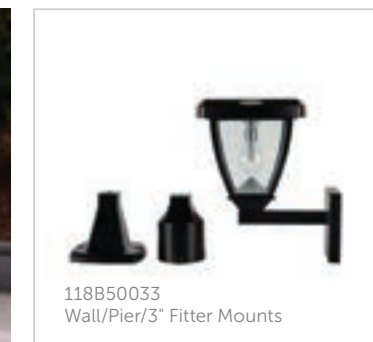

130 LUMENS
up to 15 HOURS DURATION
GS32V15 GAMA SONIC BATTERY

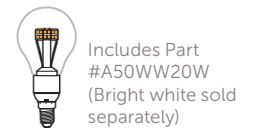

- Powered by efficient monocrystalline solar panel
- Automatic dusk to dawn operation
- Cast-aluminum weather resistant structure
- Clear glass panes
- Patents #7172307, #9458970
- 2W tempered glass solar panel

Part #	Dimensions	UPC	Wgt	LED Color	Lamp Color
118B50033	8.25L x 8.25W x 12.75H	859641008285	3.2	Warm White (2700K)	Black

Orion Solar Light



- Morph technology
- Powered by efficient monocrystalline solar panels
- Automatic dusk to dawn operation
- Rigid resin weather resistant structure
- Exterior low/off/high switch
- Patent #9458970
- 4W solar panel

150
LUMENS

up to 2
NIGHTS
DURATION

2X 
GS32V15
GAMA SONIC
BATTERY



 Includes Part #A50WW10W (Bright white sold separately)

Part #	Dimensions	UPC	Wgt	LED Color	Lamp Color
123010	8.5L x 10.5W x 13H	185455000574	3.4	Warm White (2700K)	Black
123BM50001	19L x 9W x 94.63H	859641007967	10.4		
123BM50003	23.75L x 26.25W x 94.63	859641007981	14		

Windsor Bulb Solar Light





- Automatic dusk to dawn operation
- Cast-aluminum weather resistant structure
- Beveled glass panes
- Exterior low/off/high switch
- Patents #7172307, #9458970
- 3W tempered glass solar panel

150
LUMENS

up to 12
HOURS
DURATION

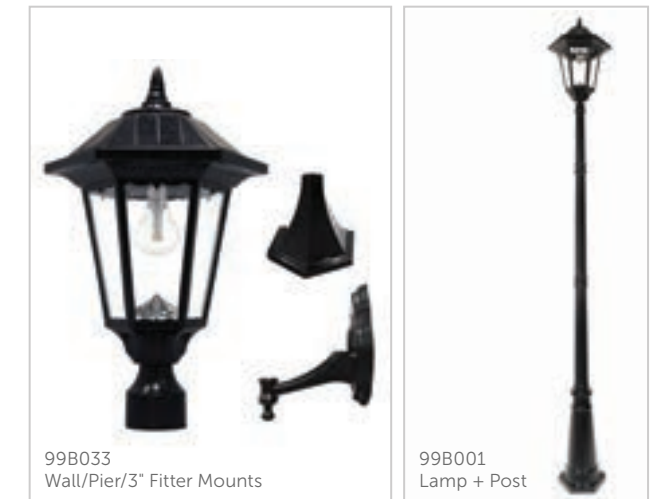
2X 
GS32V15
GAMA SONIC
BATTERY



 Includes Part #A60WW20W (Bright white sold separately)

Part #	Dimensions	UPC	Wgt	LED Color	Lamp Color
99B033	10.5L x 11.5W x 20H	859641007080	9	Warm White (2700K)	Black
99B001	10.5L x 11.5W x 96H	859641007097	16.2		

Amphora Bulb Solar Light



- Morph technology
- Automatic dusk to dawn operation
- Rigid resin weather resistant structure
- Patents #7172307, #9458970
- 1.7W tempered glass solar panel

120
LUMENS

up to 12
HOURS
DURATION

GS32V15
GAMA SONIC
BATTERY

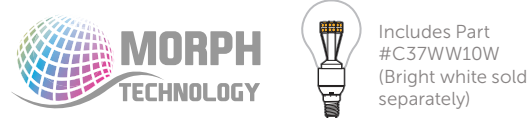

Part #	Dimensions	UPC	Wgt	LED Color	Lamp Color
12B50023	5.5L X5.5W X 12.125H	859641008490	1.8	Warm White (2700K)	Black

Casita Solar Post Light



- Morph technology
- Automatic dusk to dawn operation
- Cast-aluminum weather resistant structure
- Beveled glass panes
- Patent #7172307
- 4.8W trapezoid tempered glass solar panel

150
LUMENS

up to 2
NIGHTS
DURATION

GS32V30
GAMA SONIC
BATTERY

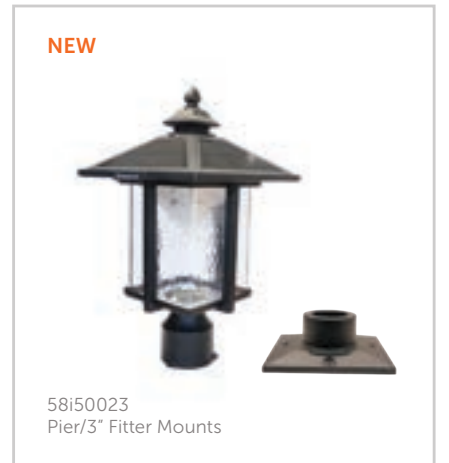

Part #	Dimensions	UPC	Wgt	LED Color	Lamp Color
58i50023	9.125L x 9.125 W x 15.25H	859641008308	6.4	Warm White (2700K)	Black

Imperial Bulb Solar Post Light



- Morph technology
- Automatic dusk to dawn operation
- Cast-aluminum weather resistant structure
- Beveled glass panes
- Patents #7172307, #9458970, #D629950
- 8.8W trapezoid tempered glass solar panel

180 LUMENS
up to 2 NIGHTS DURATION
2X GS32V30 GAMA SONIC BATTERY

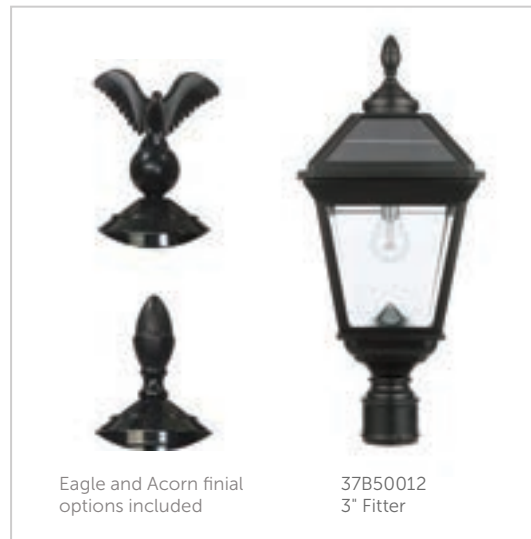

MORPH TECHNOLOGY
 Includes Part #A60WW20W (Bright white sold separately)

Part #	Dimensions	UPC	Wgt	LED Color	Lamp Color
37B50012	10.75L x 10.75W x 24.25H	859641007721	9.8	Warm White (2700K)	Black

Imperial Bulb II Solar Post Light



- Morph technology
- Powered by efficient monocrystalline solar panels
- Automatic dusk to dawn operations
- Rigid resin weather resistant structure
- Exterior low/off/high switch
- Patents #7172307, #9458970, #D629950
- 8.8W trapezoid tempered glass solar panel

180 LUMENS
up to 2 NIGHTS DURATION
2X GS32V30 GAMA SONIC BATTERY

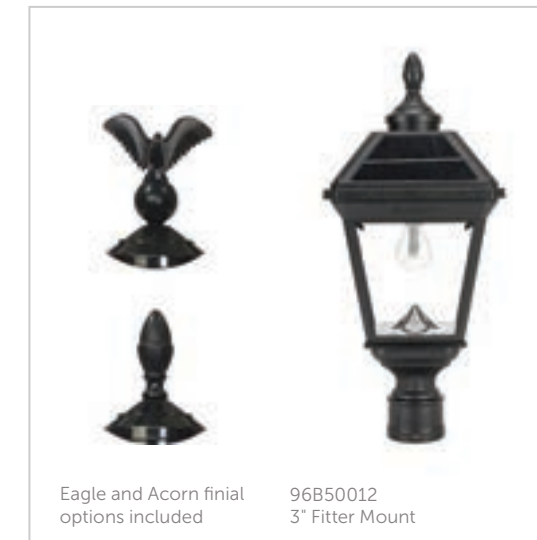

Includes Part #A60WW20W (Bright white sold separately)



MORPH TECHNOLOGY

Part #	Dimensions	UPC	Wgt	LED Color	Lamp Color
96B50012	10.63L x 10.63W x 25.63H	859641008131	6.80	Warm White (2700K)	Black

Everest Solar Lamp



- Powered by efficient monocrystalline solar panels
- Automatic dusk to dawn operation
- Acrylic lens
- Patent #9458970
- 5W tempered glass solar panel

200
LUMENS

up to 3
NIGHTS
DURATION

2X 
GS32V30
GAMA SONIC
BATTERY



Includes Part
#A60WW20W
(Bright white sold
separately)

Aspen Solar Light



- Powered by efficient monocrystalline solar panels
- Automatic dusk to dawn operation
- Cast-aluminum weather resistant structure
- Rain glass panes
- Exterior low/off/high switch
- Patent #9458970
- 3W tempered glass solar panel

120
LUMENS

up to 2
NIGHTS
DURATION

2X 
GS32V15
GAMA SONIC
BATTERY

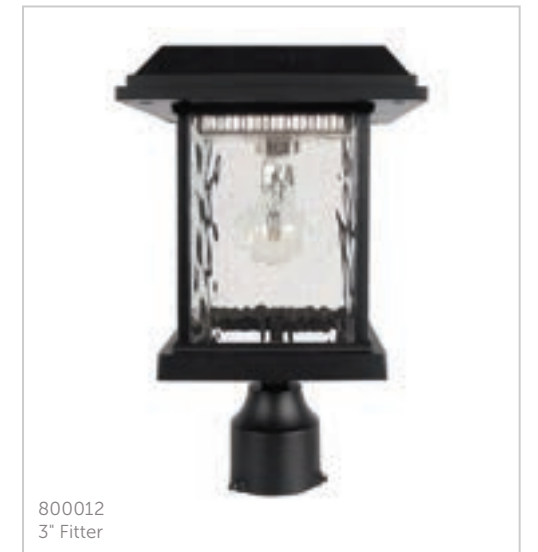

Includes Part
#A60WW20W
(Bright white sold
separately)

Part #	Dimensions	UPC	Wgt	LED Color	Lamp Color
109012	23L x 11W x 19.5H	853153005848	11	Warm White (2700K)	Black
109001	23L x 11W x 92H	853153005824	17		

Part #	Dimensions	UPC	Wgt	LED Color	Lamp Color
800012	9L x 9W x 15H	859641007134	7	Warm White (2700K)	Black

Spiral Solar Light



- Morph technology
- Automatic dusk to dawn operation
- Cast-aluminum weather resistant structure
- Beveled glass panes
- Exterior low/off/high switch
- Patents #7172307, #9458970, #D629950
- 8W trapezoid tempered glass solar panel

150
LUMENS
 up to 2
NIGHTS
DURATION
 2X
GS32V30
GAMA SONIC
BATTERY



Includes Part
#A60WW20W
(Bright white
sold separately)



Part #	Dimensions	UPC	Wgt	LED Color	Lamp Color
133B50012	11.88L x 11.88W x 20.00H	859641007738	7.6	Warm White (2700K)	Black

Solar Coach Lantern



- Powered by efficient monocrystalline solar panel
- Automatic dusk to dawn operation
- Cast-aluminum weather resistant structure
- Glass panes
- Exterior low/off/high switch
- Patent #9458970
- 1W tempered glass solar panel

60
LUMENS
 up to 12
HOURS
DURATION
 GS32V15
GAMA SONIC
BATTERY

Includes Part
#T45WW10W

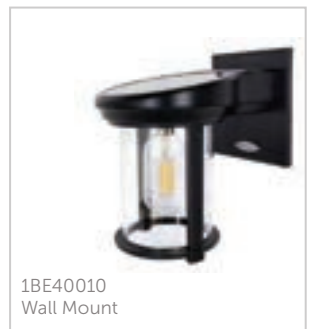

Part #	Quantity	Dimensions	UPC	Wgt	LED Color	Lamp Color
1BE40010	1 Pack	7L x 5.5W x 7.5H	859641007707	2	Warm White (2400K)	Black
1BP2E40010	2 Pack		859641008841			Black
1BE40810	1 Pack		859641008360			Grey
1BP2E40810	2 Pack		859641008858		Warm White (2700K)	Grey

Farmhouse Solar Light



- Powered by efficient TSP technology (patent pending) with monocrystalline solar panels
- Automatic dusk to dawn operation
- Cast-aluminum weather resistant structure
- Reeded glass panes
- Patent #9458970
- 3.4W tempered glass solar panel

130
LUMENS

up to 2
NIGHTS
DURATION

2X
GS32V15
GAMA SONIC
BATTERY



Translucent Solar Panels

Includes Part #A60WW20W (Bright white sold separately)

Part #	Dimensions	UPC	Wgt	LED Color	Lamp Color
130010	6.5L x 7.5W x 15.5H	859641007264	7	Warm White (2700K)	Black

Infinity Solar Up and Down Wall Light



- Morph technology
- Dual color - bright white/warm white
- Automatic dusk to dawn operation
- Powered by efficient monocrystalline solar panels
- Rigid ABS resin weather resistant structure
- Exterior low/off/high switch
- 3.6W solar panel

150
LUMENS

up to 2
NIGHTS
DURATION

GS32V30
GAMA SONIC
BATTERY

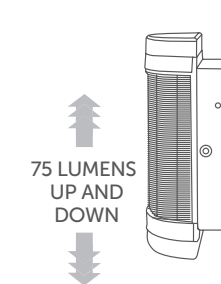

MORPH TECHNOLOGY

Part #	Dimensions	UPC	Wgt	LED Color	Lamp Color
120010	3.74L x 4.8W x 9.44H	859641007257	2.31	Bright White (6000K) + Warm White (2700K)	Black

Cottage Solar Barn Light



- Morph Technology
- Powered by efficient monocrystalline solar panels
- Automatic dusk to dawn operation
- Cast-aluminum weather resistant structure
- Patents #9458970
- 8.4W tempered glass solar panel

250
LUMENS

up to 3
NIGHTS
DURATION

2x
GS32V30
GAMA SONIC
BATTERY

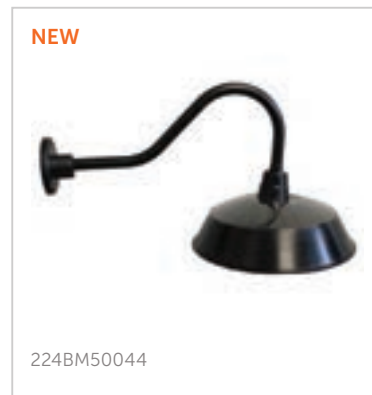

Part #	Dimensions	UPC	Wgt	LED Color	Lamp Color
224BM50044	28L x 14.5W x 15H	859641008988	5.2	Warm White (2700K)	Black

Solar Address Wall Plaque Light with Ground Stakes

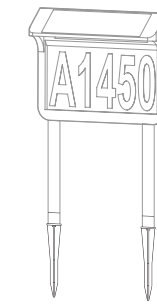

- 4pcs each of 0-9 | 1 each of A,B,C,D,E
- Dual color - bright white/warm white
- Automatic dusk to dawn operations
- Cast aluminum finish weather resistant structure
- Powered by efficient monocrystalline solar panels
- 1.5W solar panel

15
LUMENS

up to 1
NIGHT
DURATION

SB37V08
GAMA SONIC
BATTERY

Part #	Dimensions	UPC	Wgt	LED Color	Lamp Color
81i90010	2.25L x 10.68W x 8.13H	59641008254	1.2	Bright White (6000K) + Warm White (2700K)	Black

Solar Address Light

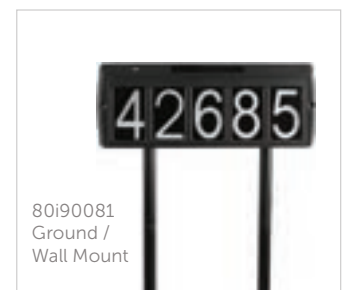

- 3 pcs of each number 0-9, 1 each of N, S, E, W and 2 blank pieces
- Dual color - bright white /warm white
- Automatic dusk to dawn operation
- Rigid resin weather resistant structure
- Powered by efficient monocrystalline solar panel
- 0.5W solar panel

25
LUMENS

up to 12
HOURS
DURATION

Ni-Cd
1.2V1000mAh
AA
RECHARGEABLE
BATTERY

Part #	Dimensions	UPC	Wgt	LED Color	Lamp Color
80i90081	1.13L x 14.25W x 5.50H	859641008162	1	Bright White (6000K) + Warm White (2700K)	Black

Modern Solar Post Light



Bright White



Warm White

- Cast-aluminum weather resistant structure
- Automatic dusk to dawn operation
- Dual color temperature: switch between warm white (3100K) or bright white (6000K)
- Powered by efficient tempered glass monocrystalline solar panels
- Exterior low/off/high switch
- Patent #7172307
- 3W tempered glass solar panel



150
LUMENS



up to 2
NIGHTS
DURATION



2x
GS32V15
GAMA SONIC
BATTERY



132I90012
3" Fitter



BP28INEZ0
28" Bollard Post w/EZ Anchor
Sold separately

Part #	Dimensions	UPC	Wgt	LED Color	Lamp Color
132I90012	9L x 8.5W x 13H	859641007677	3.9	Bright White (6000K) + Warm White (3100K)	Black
BP28INEZ0	5L x 5W x 28.25H	859641007844	2.40	n/a	

Stainless Steel Bollard Solar Light w/ EZ Anchor



- Stainless steel
- Automatic dusk to dawn operation
- Clear glass pane
- Mini EZ anchor kit included
- Patent #9458970
- 1W tempered glass solar panel



100
LUMENS



up to 12
HOURS
DURATION



2x
GS32V10
GAMA SONIC
BATTERY



Mini Ez Anchor Kit

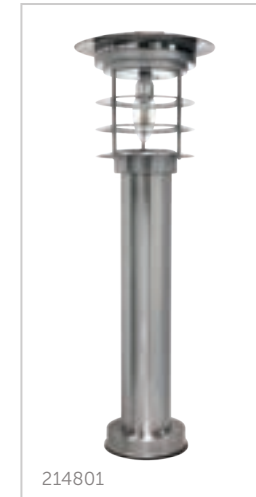

214801



214001



Includes Part
#C37WW10W
(Bright white
sold separately)

Part #	Quantity	Dimensions	UPC	Wgt	LED Color	Lamp Color
214801	1 Pack	8L x 8W x 24.25H	853153005961	6	Warm White (2700K)	Silver
214BP250870	2 Pack		859641008186			Silver
214001	1 Pack		859641007202			Black
214BP250070	2 Pack		859641008087			Black

Contemporary Square Solar Path Light



Warm White

- Dual color - bright white/warm white
- Powered by efficient monocrystalline solar panels
- Automatic dusk to dawn operation
- Cast-aluminum weather resistant structure
- Exterior High/Off/Low switch
- 2W tempered glass solar panel
- 6x more charging power than an average solar light

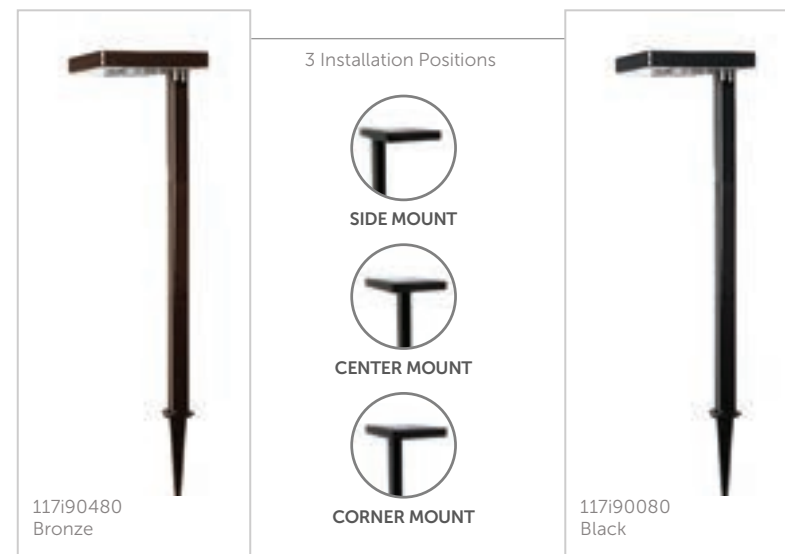

80 LUMENS
up to 2 NIGHTS DURATION
GS37V20FLT GAMA SONIC BATTERY

Part #	Quantity	Dimensions	UPC	Wgt	LED Color	Lamp Color
117i90080	1 Pack	6.13L x 6.13W x 26.75H	859641007752	2.2	Bright White (6000K) + Warm White (2700K)	Black
117iP290080	2 Pack		859641008322			Black
117i90480	1 Pack		859641008124			Bronze
117iP290480	2 Pack		859641008339			Bronze

Sentry Modern Pathway Solar Light Set of 2



- Powered by efficient monocrystalline solar panels
- Automatic dusk to dawn operations
- Cast-aluminum finish weather resistant structure
- LED Color:
 - Bright white with white accent
 - Bright white with blue accent
 - Bright white with orange accent
- 1.2W tempered glass solar panel

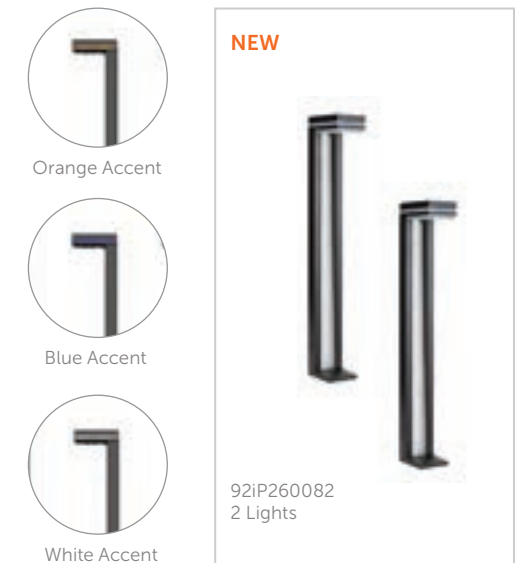

60 LUMENS
up to 2 NIGHTS DURATION
GS32V15 GAMA SONIC BATTERY

Part #	Dimensions	UPC	Wgt	LED Color	Lamp Color
92iP260082	4.75L x 3W x 24H	859641008483	2	Bright White with White Accent	Black
92iP270082		859641008520		Bright White with Orange Accent	
92iP280082		859641008513		Bright White with Blue Accent	

Solar Garden Light Shepherd Hook



- Morph technology
- Powered by efficient monocrystalline solar panels
- Automatic dusk to dawn operation
- Cast-aluminum pole
- Rigid resin weather resistant frame
- Patent #9458970
- 4.8W tempered glass solar panel
- 8x more charging power than the average solar light



148101
Shepherd Hook



80
LUMENS

up to 12
HOURS
DURATION

GS32V15
GAMA SONIC
BATTERY

Dual Color Premier Solar Garden Light



Warm White

- Dual color - bright white/warm white
- Automatic dusk to dawn operation
- Cast-aluminum weather resistant structure
- Exterior warm/off/bright switch
- Fluted glass
- Patent #7172307
- 0.8W tempered glass solar panel

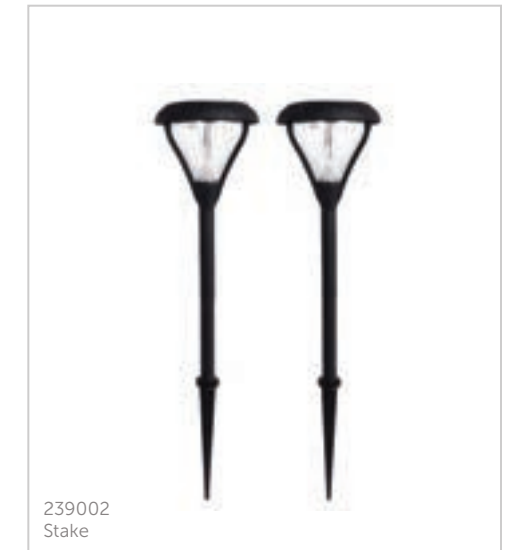

239002
Stake

50
LUMENS

up to 10
HOURS
DURATION

GS32V10
GAMA SONIC
BATTERY

Part #	Quantity	Dimensions	UPC	Wgt	LED Color	Lamp Color
148101	1 Pack	7L x 7W x 21.5H	859641007684	2.8	Warm White (2700K)	Black
148BP250080	2 Pack		859641008537			

Part #	Quantity	Dimensions	UPC	Wgt	LED Color	Lamp Color
239002	2 Pack	6L x 6W x 23.5H	859641007158	4	Bright White (6000K) + Warm White (2700K)	Black
239iP490080	4 Pack		859641008544			

Progressive Solar Spotlight



- Cast-aluminum weather resistant structure
- 2 mounting options
- Remote solar panel
- Exterior on/off switch
- 2W tempered glass solar panel
- Detachable panel with 6 ft cord

100
LUMENS

up to 10
HOURS
DURATION



GS32V30
GAMA SONIC
BATTERY



103001
Stake Mount

Part #	Dimensions	UPC	Wgt	LED Color	Lamp Color
103001	7L x 5W x 15H	185455000819	4.2	Bright White (6000K)	Black
103001-5		185455000888		Warm White (3100K)	

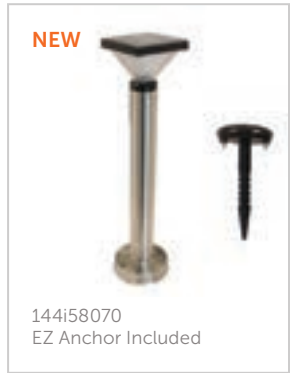
Luxor Stainless Steel Bollard Solar Light



144i58070
EZ Anchor Included

- Powered by efficient monocrystalline solar panels
- Automatic dusk to dawn operation
- Cast-aluminum weather resistant structure
- 1.6W tempered glass solar panel

50
LUMENS

up to 2
NIGHTS
DURATION

GS32V15
GAMA SONIC
BATTERY

Part #	Dimensions	UPC	Wgt	LED Color	Lamp Color
144i58070	5L x 5W x 20.25H	859641008964	1.85	Warm White (2700K)	Black

Luxor Solar Pathway Light Set of 2



146iP250080
Stake

- Powered by efficient monocrystalline solar panels
- Automatic dusk to dawn operation
- Cast-aluminum weather resistant structure
- 1.6W tempered glass solar panel

50
LUMENS

up to 2
NIGHTS
DURATION

GS32V15
GAMA SONIC
BATTERY

Part #	Dimensions	UPC	Wgt	LED Color	Lamp Color
146iP250080	4.375L x 4.375W x 23H	859641008971	1.6	Warm White	Black

Luxor Solar Post Cap Light Set of 2



Black



White

- Powered by efficient monocrystalline solar panels
- Automatic dusk to dawn operation
- Rigid ABS Resin exterior
- 1.2W tempered glass solar panel



50
LUMENS



up to 2
NIGHTS
DURATION



GS32V15
GAMA SONIC
BATTERY



Part #	Quantity	Dimensions	UPC	Wgt	LED Color	Lamp Color
144iP2500KIT	2 Pack	4.375L x 4.375W x 4H	859641008940	0.6	Warm White (2700K)	Black
144iP2502KIT	2 Pack		859641008957			

Gothic Solar Post Cap Light Set of 2



Black

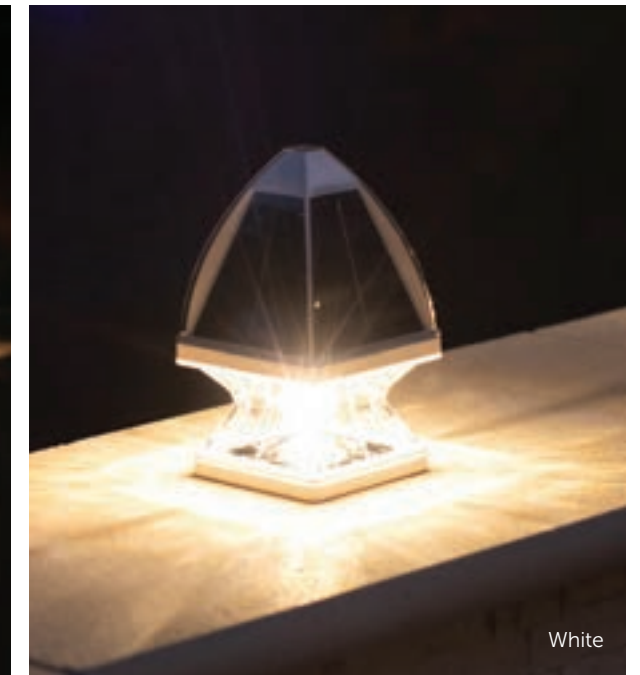

White

- Powered by efficient monocrystalline solar panels
- Automatic dusk to dawn operation
- Exterior low/off/high switch
- Dual color temperature: switch between warm white (3100K) or bright white (6000K)
- Rigid ABS resin exterior
- Patent #7172307
- 2.65W tempered glass solar panel



40
LUMENS



up to 2
NIGHTS
DURATION



GS32V15
GAMA SONIC
BATTERY

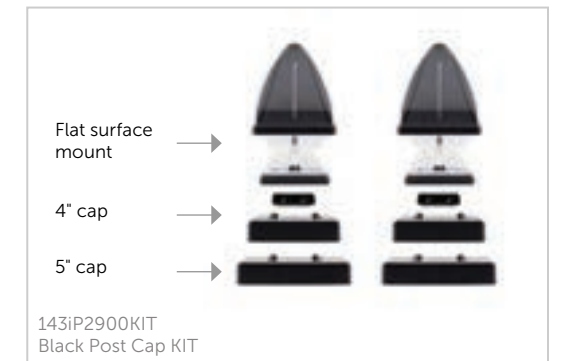

Part #	Quantity	Dimensions	UPC	Wgt	LED Color	Lamp Color
143iP2900KIT	2 Pack	3.6L x 3.6W x 7H	859641007363	1.56	Bright White (6000K) + Warm White (2700K)	Black
143iP2902KIT	2 Pack		85964100737			

Solar Uplight Planter Base



- Rigid resin weather resistant structure
- Power by efficient monocrystalline solar panels
- Exterior On/Off switch
- 1.65W tempered glass solar panel

50
LUMENS

up to 12
HOURS
DURATION

SB37V20
GAMA SONIC
BATTERY



Luna II Solar Post Cap/Pier Mount Light Set of 2



- Powered by efficient monocrystalline solar panels
- Automatic dusk to dawn operation
- 1.2W tempered glass solar panel
- Patent #7172307, 9458970
- 2 mounting options: 4x4 fence post cap mount and pier mount

50
LUMENS

up to 2
NIGHTS
DURATION

GS32V15
GAMA SONIC
BATTERY

NEW



84BP250011
Post Cap and
Pier Mount



Includes Part
#D46WW05W
(Bright white sold
separately)

Part #	Quantity	Dimensions	UPC	Wgt	LED Color	Lamp Color
77i50265	1 Pack	10.63L x 10.63W x 1.4H	859641008216	1.4	Warm White (2700K)	White
77iP250265	2 Pack		859641008872			

Part #	Quantity	Dimensions	UPC	Wgt	LED Color	Lamp Color
84BP250011	2 Pack	5L x 5W x 9L	859641008834	2.4	Warm White (2700K)	Black



Motion Activated Security Light



Backlit Accent Light

Architectural Solar Wall Accent Light w/ Motion Sensor

- Cast-aluminum weather resistant structure
- Powered by efficient monocrystalline solar panel
- Exterior low/off/high switch
- Automatic dusk to dawn operation
- Bright white (6000K) motion activated security light
- Warm white (2700K) backlit accent light
- 1.2W tempered glass solar panel

120
LUMENS

up to 18
HOURS
DURATION

GS32V15
GAMA SONIC
BATTERY



4iS50010
Black Wall Light



4iS50410
Bronze Wall Light

 Integrated PIR
motion sensor

Part #	Quantity	Dimensions	UPC	Wgt	LED Color	Lamp Color
4iS50410	1 Pack	3L x 8W x 5H	859641008063	1.2	Warm White (2700K)	Bronze
4iP2S50410	2 Pack		859641008070			
4iS50010	1 Pack		859641008049			Black
4iP2S50010	2 Pack		859641008056			

Mosaic Tea Candle Solar Light



- 3 different mosaic colors in one box: green, orange and purple
- On/Off switch
- 0.3W solar panels

5
LUMENS

up to 16
HOURS
DURATION

RECHARGEABLE
BATTERY

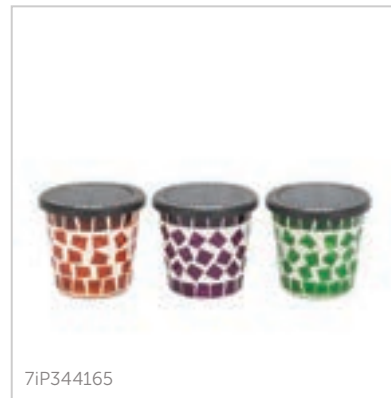

7IP344165

Emergency and Camping Solar Flashlight with USB Charging Port



- Powered by efficient monocrystalline solar panels
- Automatic dusk to dawn operation
- Automatic emergency light
- Features two charging options: solar or USB
- 3 in 1: Emergency Light/Flashlight/Power Bank 4000mAh
- 4 light mode options: spotlight, low, high, strobe/flash
- 3W tempered glass solar panel

1000
LUMENS

up to 15
HOURS
DURATION

2X
SB37V20
GAMA SONIC
BATTERY

NEW



23I60065

Part #	Quantity	Dimensions	UPC	Wgt	LED Color	Lamp Color
7IP344165	3 pack	3.38L x 3.38W x 3.13H	859641008162	1.8	Warm White (2400K)	Multi Colored
7IP644165	6 pack		859641008551			

Part #	Dimensions	UPC	Wgt	LED Color	Lamp Color
23I60065	3.25L x 8.25W x 8.75H	859641008278	1.6	Bright White (2700K)	Black

Light My Shed® IV



16B02
Panel + Double Lamp



Includes Part #
A60BW20W
(Bright white sold
separately)

- Adjustable separate solar panel (up to 9 ft. away)
- Rigid resin
- Remote solar panel
- Patents #D543500, #9458970
- 3W solar panel

500
LUMENS

up to 4
HOURS
DURATION

GS48V20
GAMA SONIC
BATTERY

Part #	Dimensions	UPC	Wgt	LED Color	Lamp Color
16B02	6.5L x 6.5W x 7H	859641007066	5.2	Bright White (6000K)	White / Grey

Solar Yard Light



Direct to Wall

- Two mounting options: direct-to-wall and extended arm mount
- Dual color temperature: switch between warm white (3100K) or bright white (6000K)
- Automatic dusk-to-dawn operation
- Powered by efficient monocrystalline solar panel
- Weather resistant, heavy duty resin
- 2.5W tempered glass solar panel

300
LUMENS

12
HOURS
DURATION

2X 
GS37V20
GAMA SONIC
BATTERY



17IS90810
Wall Mount
Extended Arm Mount

 Integrated PIR
motion sensor

Part #	Quantity	Dimensions	UPC	Wgt	LED Color	Lamp Color
17IS90810	1 Pack	5L x 25.5W x 11H	859641007820	5	Bright White (6000K) + Warm White (2700K)	Grey
17IP2S90810	2 Pack		859641008865			

Accessories

Batteries

Gama Sonic® uses the highest quality batteries and technology to power our solar lights. Our batteries are strategically matched with a solar lamp to maximize its duration and brightness. As technology continues to be increasingly important in the growing solar lighting world, we set the industry standard on quality battery solutions. We only use specially designed products that are packed, sealed, and use an external harness to eliminate corrosion and provide the superior charging and powering of the light our customers expect.

To learn more visit gamasonic.com

New turtle safe bulbs available*

- A50TL10W
- A60TL20W
- C37TL10W

GS Solar LED Light Bulb

Patent #945897

Works only with Gama Sonic bulb series fixtures

A50WW10W A50BW10W A50TL10W* 11 LEDs 220mA/0.7W	A60WW30W A60BW30W A60TL20W* 27 LEDs 1A/3.5W	A60WW20W A60BW20W A60TL20W* 11 LEDs 440mA/1.5W
C37WW10W C37BW10W C37TL10W* 11 LEDs 600mA/2W	A60WW20W-DIR A60BW20W-DIR 4+7 LEDs 440mA/1.5W	T45WW10W Filament Style 220mA/0.75W
F30WW05W Simulated Flame Style 40 LEDs 220mA/0.75W	D46WW05W 6 LEDs 220mA/0.75W	

LED TECHNOLOGY

2400K 2700K 3100K 6000K 9000K

1500K

Warm Light | Bright White | Day Light

EZ-Anchor Solar Lamp Post Anchor Kit



*Not applicable on commercial posts

Pier Base Mount for 3" Post Top Mounts



Universal Wall Bracket



STEP 1: Install the EZ Anchor

STEP 2: Secure the lamp post base to the EZ Anchor

STEP 3: You're done! Let the sun do the rest.

NOTE: 30001 EZ-Anchor Lamp Post Base is built to support ONLY single lamps on a Gama Sonic® Decorative or Imperial Post. DO NOT USE to support multi-lamp products.

Part #	UPC	Pkg. Size (in)	Wgt
30001	185455000024	26L x 12W x 12H	6
97NWKITO	NA	9L x 8W x 6H	1.5
PBM00	859641007387	6.25L x 6.25W x 2.25H	0.4



Posts

- All our poles fit most 3" post top fixtures
- Matte finish cast aluminum weather resistant poles

Commercial Posts

CP65F0 6.5 FT.

CP8F0 8 FT.

CP10F0 10 FT.

**DBP10F0 10 FT.

** Requires freight shipping

Residential Posts

BP28INEZ0 28" Bollard Post w/EZ Anchor Sold separately

DPEZ5F0 Black 64"

97SP0 Black 78"

DP55F2 White 68"-79"

DP55F0 Black 68"-79"

NEW

* MP8F0 Black 96"

* Only applicable to 217I20012 and 66B50010

Part #	UPC	Pkg. Size (in)	Wgt
CP65F0	853153005855	11.6L x 15.5W x 29H	20
CP8F0	853153005756	11.6L x 15.5W x 38H	22
CP10F0	853153005763	11.6L x 15.5W x 48.5H	25
DP55F2	185455000239	9L x 11W x 24H	8
DP55F0	185455000185		
97SP0	185455000031	12.5L x 10W x 32H	11
DPEZ5F0	859641008148	9.75L x 25.13W x 13H	8
DBP10F0	859641008353	3L x 3W x 143.25H	19.6
MP8F0	859641008803	COMING SOON	COMING SOON
BP28INEZ0	859641007844	5L x 5W x 28.25H	2.40

GAMA SONIC[®]
SOLAR LIGHTING

Gama Sonic USA Inc.

6185-F Jimmy Carter Boulevard
Norcross, Georgia 30071 USA

info@gamasonic.com

Tel: 1 800 835 4113
Fax: 1 800 835 4173